

4(M5) HOLE
ON PATTERN SHOWN

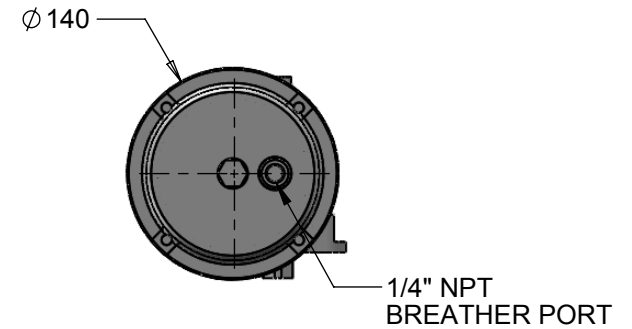

(4) M8 HOLE
ON F07 PATTERN

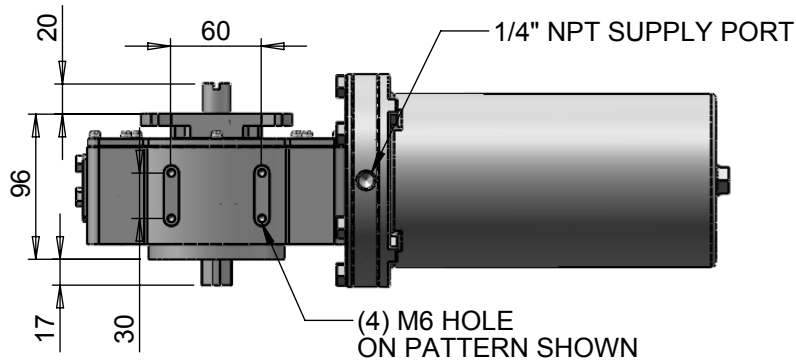
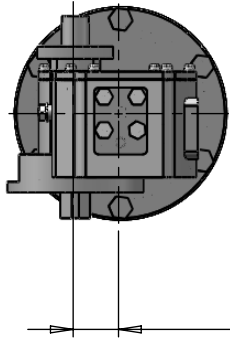
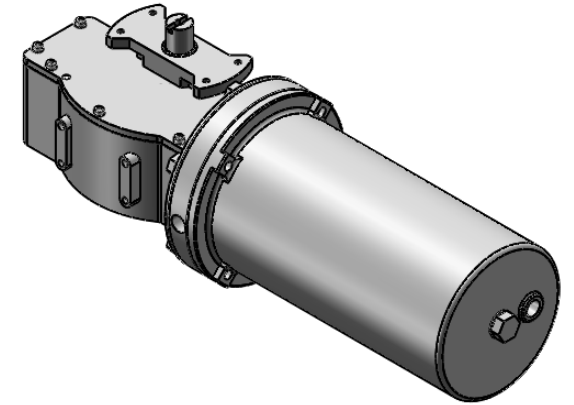
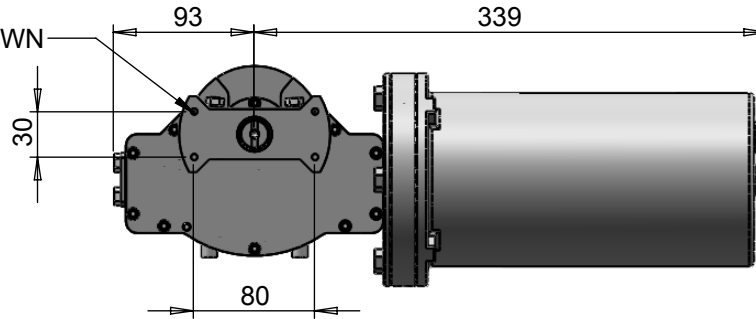
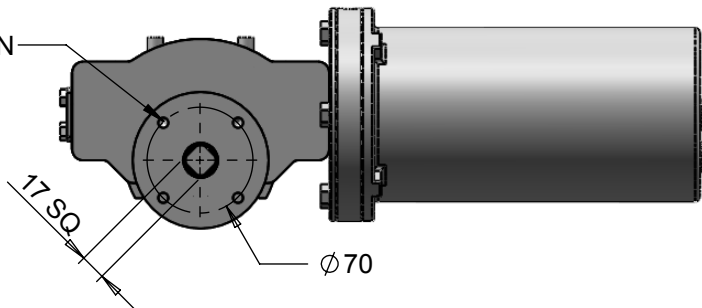

REV	DRAWN	DATE	CHK'D	ECO
	PT	23.5.13		13-2076

UNLESS OTHERWISE SPECIFIED:
DIMENSIONS ARE IN MILLIMETERS
SURFACE FINISH: 3.2
TOLERANCES:
LINEAR: ±0.25mm
ANGULAR: ±0.5°

TITLE:
**CS/CX30-SR1 - Single Cyl -
Dimensional Drawing**

This private & confidential drawing is the property of Camtorc Actuators, Tonbridge, UK and cannot be copied or reproduced without the express written permission of the Company.

Camtorc Actuators
PO Box 23, Tonbridge, Kent, TN11 9NY,
United Kingdom. Tel:+44(0)870-0340002
Website: www.camtorc.com

DEBUR AND
BREAK SHARP
EDGES
MATERIAL:
WEIGHT: - Excl Valve

DWG NO.
CS-CX30-SRxx2-DIM001

SCALE:1:5

SHEET 1 OF 1

ACTIVE
STATUS
A4